

CANTER 3S13

LEFT-HAND DRIVE

MODEL / VEHICLE TYPE 3S13

Cab type / crew	Standard, single cab / 3		
Model variant	46900211	46900311	46900511
FUSO model code	FEA01BL4SEUW	FEA01CL4SEUW	FEA01EL4SEUW

DIMENSIONS [MM]

Wheelbase	2500	2800	3400
Overall length	4640	4990	5790
Cab length		1510	
Width overall		1798	
Cab width		1695	
Height overall		2105	
Track width	Front / rear	1405 / 1255	
Frame height (at end of frame)		725	
Ground clearance		165	
Cab to rear axle	1975	2275	2875
Cab to end of frame	3120	3470	4270
Maximum body length**	3500	3995	4985
Frame width		700	
Front overhang		995	
Rear overhang	1145	1195	1395
Front axle to front of body		625	
Recommended distance cab to body		100	

WEIGHTS [KG]

Empty weight*		1940	1950	1980
	Front* / rear*	1420 / 520	1440 / 510	1445 / 535
Minimum vehicle weight		2355		
Gross vehicle weight / gross combination weight		3500 / 7000		
Axle loads*	Front / rear	1950 / 2500		
	Towed weight	Braked / unbraked	3500 / 750	
Chassis load bearing capacity*		1560	1550	1520

CALCULATED OUTPUT

Maximum speed	km/h	140		
Minimum turning circle [m]	Kerb to kerb	9.0	10.0	11.8
	Wall to wall	10.2	11.2	13.0

* The weight refers to the base vehicle (European series, including coolant, oil, 90% fuel, tyre sealant, tools and driver with 75 kg) without optional equipment. If any optional equipment is added, the weight changes accordingly. ** Calculated maximum value which should be checked depending on the body and application.
Subject to change without notice. All data is approximate. The illustrations may contain accessories and items of optional equipment which are not part of the standard specification. The data sheet may contain product types and support services not available in certain countries.

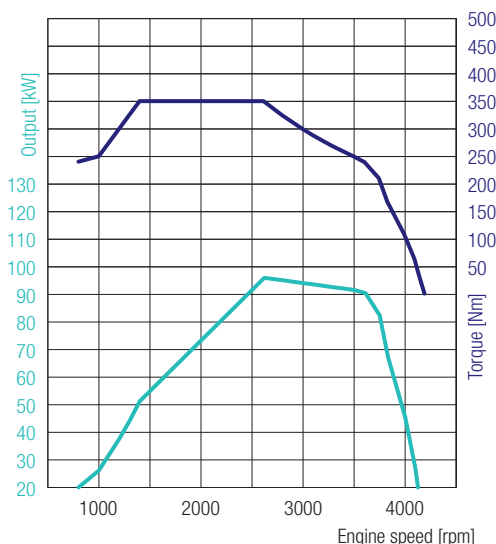

CANTER 3S13

LEFT-HAND DRIVE

4P10 – 96 kW (130 PS)
 350 Nm@1400 rpm
 96 kW@2620 rpm

ENGINE (EURO VI)

Type	Water-cooled four-stroke diesel engine with turbocharger, intercooler and direct injection		
No. of cylinders	4/in-line		
Capacity	2998 cm ³		
Peak output	96 kW (130 hp) / 2620 rpm		
Rated torque	350 Nm / 1400 rpm		
Diesel particulate filter	Service life approx. 300,000 km		
Alternator	Alternating current 12 V, 140 A		
Exhaust gas aftertreatment	DPF + SCR		
PTO (optional)	Type	31 kW with flange	31 kW for directly connected pumps
	Torque at peak output [Nm]:	196 Nm	
	Gear ratios	1:0.655	1:0.651
	Engine speed at peak output	1500 rpm	

POWERTRAIN

Transmission	Model	Manual gearbox, 5 forward gears, 1 reverse gear
	Gear ratio	5.494 / 3.193 / 1.689 / 1.000 / 0.723 / reverse 5.494
Rear axle gear ratio	Ratio	4.111

CHASSIS

Front axle / rear axle	Model	F100T / R015T
	Load-bearing capacity front/rear	1950 kg / 2500 kg
Tyres		195/75R16C 107/105 R
		Twin tyres at rear
Wheel		16 x 5 JK - 110
Steering		Left-hand drive
		Rack-and-pinion steering with power assist, tilting telescopic steering column with steering-wheel lock
Brake	Service brake	Hydraulic with vacuum power assist, dual-circuit with load-dependent brake proportioning valve at rear wheels
	Front / rear	Disc brake (217 x 24)
	Parking brake	Mechanical expanding brake on drive shaft at rear of transmission
	Auxiliary brake	Exhaust brake (50 kW)
Suspension	Front / rear	Independent wheel suspension (coil spring) with shock absorber / semi-elliptic leaf spring with shock absorber
Frame	Type	Ladder-type frame with reinforcements and crossmembers
Fuel tank capacity		70 litres
Electrical system	Batteries	12 V (100 Ah - 760 A(EN))

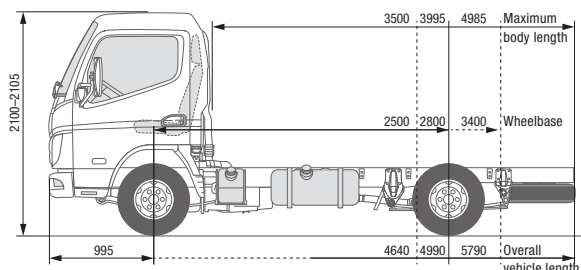
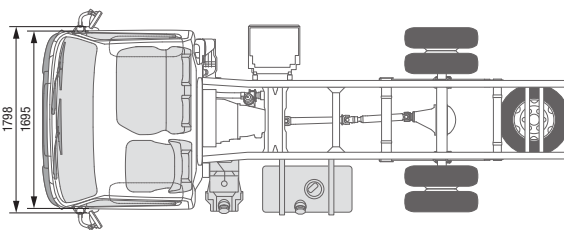

CANTER 3S13 DUONIC® 2.0

LEFT-HAND DRIVE

MODEL / VEHICLE TYPE 3S13

Cab type / crew	Standard, single cab / 3		
Model variant	46901211	46901311	46901511
FUSO model code	FEA01BL3SEUW	FEA01CL3SEUW	FEA01EL3SEUW

DIMENSIONS [MM]

Wheelbase	2500	2800	3400
Overall length	4640	4990	5790
Cab length		1510	
Width overall		1798	
Cab width		1695	
Height overall		2100	2105
Track width	Front / rear	1405 / 1255	
Frame height (at end of frame)		715	710
Ground clearance		165	
Cab to rear axle		1975	2875
Cab to end of frame		3120	4270
Maximum body length**		3500	4985
Frame width		700	
Front overhang		995	
Rear overhang		1145	1395
Front axle to front of body		625	
Recommended distance cab to body		100	

WEIGHTS [KG]

Empty weight*		1960	1970	1990
	Front* / rear*	1440 / 520	1455 / 515	1455 / 535
Minimum vehicle weight		2180	2205	
Gross vehicle weight / gross combination weight		3500 / 7000		
Axle loads*	Front / rear	1950 / 2500		
Towed weight	Braked / unbraked	3500 / 750		
Chassis load bearing capacity*		1540	1530	1510

CALCULATED OUTPUT

Maximum speed	km/h	140		
Minimum turning circle [m]	Kerb to kerb	9.0	10.0	11.8
	Wall to wall	10.2	11.2	13.0

* The weight refers to the base vehicle (European series, including coolant, oil, 90% fuel, tyre sealant, tools and driver with 75 kg) without optional equipment. If any optional equipment is added, the weight changes accordingly. ** Calculated maximum value which should be checked depending on the body and application. Subject to change without notice. All data is approximate. The illustrations may contain accessories and items of optional equipment which are not part of the standard specification. The data sheet may contain product types and support services not available in certain countries.

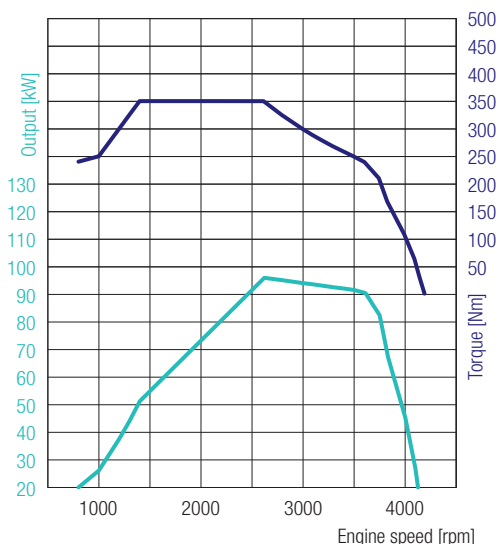

CANTER 3S13 DUONIC® 2.0

LEFT-HAND DRIVE

4P10 – 96 kW (130 PS)
 350 Nm@1400 rpm
 96 kW@2620 rpm

ENGINE (EURO VI)

Type	Water-cooled four-stroke diesel engine with turbocharger, intercooler and direct injection		
No. of cylinders	4/in-line		
Capacity	2998 cm ³		
Peak output	96 kW (130 hp) / 2620 rpm		
Rated torque	350 Nm / 1400 rpm		
Diesel particulate filter	Service life approx. 300,000 km		
Alternator	Alternating current 12 V, 140 A		
Exhaust gas aftertreatment	DPF + SCR		
PTO (optional)	Type	31 kW with flange	31 kW for directly connected pumps
	Torque at peak output [Nm]:	196 Nm	
	Gear ratios	1:0.655	1:0.651
	Engine speed at peak output	1500 rpm	

POWERTRAIN

Transmission	Model	DUONIC® 2.0: Automated transmission with dual clutch, 6 forward speeds and 1 reverse gear
	Gear ratio	5.397 / 3.788 / 2.310 / 1.474 / 1.000 / 0.701 / reverse 5.397
Rear axle gear ratio	Ratio	4.111

CHASSIS

Front axle / rear axle	Model	F100T / R015T
	Load-bearing capacity front/rear	1950 kg / 2500 kg
Tyres		195/75R16C 107/105 R
		Twin tyres at rear
Wheel		16 x 5 JK - 110
Steering		Left-hand drive
		Rack-and-pinion steering with power assist, tilting telescopic steering column with steering-wheel lock
Brake	Service brake	Hydraulic with vacuum power assist, dual-circuit with load-dependent brake proportioning valve at rear wheels
	Front / rear	Disc brake (217 x 24)
	Parking brake	Mechanical expanding brake on drive shaft at rear of transmission
	Auxiliary brake	Exhaust brake (50 kW)
Suspension	Front / rear	Independent wheel suspension (coil spring) with shock absorber / semi-elliptic leaf spring with shock absorber
Frame	Type	Ladder-type frame with reinforcements and crossmembers
Fuel tank capacity		70 litres
Electrical system	Batteries	12 V (100 Ah - 760 A(EN))

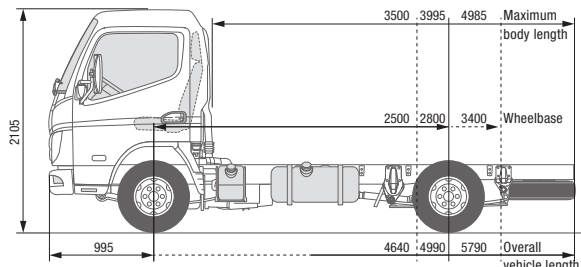
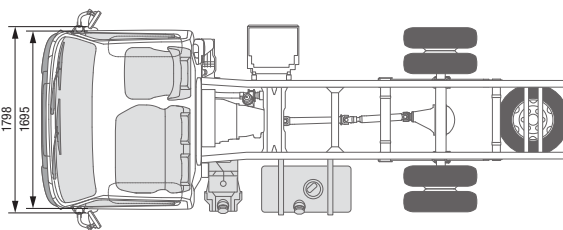

CANTER 3S13

RIGHT-HAND DRIVE

MODEL / VEHICLE TYPE 3S13

Cab type / crew	Standard, single cab / 3		
Model variant	46900221	46900321	46900521
FUSO model code	FEA01BR4SEUW	FEA01CR4SEUW	FEA01ER4SEUW

DIMENSIONS [MM]

Wheelbase	2500	2800	3400
Overall length	4640	4990	5790
Cab length		1510	
Width overall		1798	
Cab width		1695	
Height overall		2105	
Track width	Front / rear	1405 / 1255	
Frame height (at end of frame)		715	
Ground clearance		165	
Cab to rear axle	1975	2275	2875
Cab to end of frame	3120	3470	4270
Maximum body length**	3500	3995	4985
Frame width		700	
Front overhang		995	
Rear overhang	1145	1195	1395
Front axle to front of body		625	
Recommended distance cab to body		100	

WEIGHTS [KG]

Empty weight*		1940	1950	1980
	Front* / rear*	1420 / 520	1440 / 510	1445 / 535
Minimum vehicle weight		2355		
Gross vehicle weight / gross combination weight		3500 / 7000		
Axle loads*	Front / rear	1950 / 2500		
	Towed weight	Braked / unbraked	3500 / 750	
Chassis load bearing capacity*		1560	1550	1520

CALCULATED OUTPUT

Maximum speed	km/h	140		
Minimum turning circle [m]	Kerb to kerb	9.0	10.0	9.0
	Wall to wall	10.2	11.2	10.2

* The weight refers to the base vehicle (European series, including coolant, oil, 90% fuel, tyre sealant, tools and driver with 75 kg) without optional equipment. If any optional equipment is added, the weight changes accordingly. ** Calculated maximum value which should be checked depending on the body and application. Subject to change without notice. All data is approximate. The illustrations may contain accessories and items of optional equipment which are not part of the standard specification. The data sheet may contain product types and support services not available in certain countries.

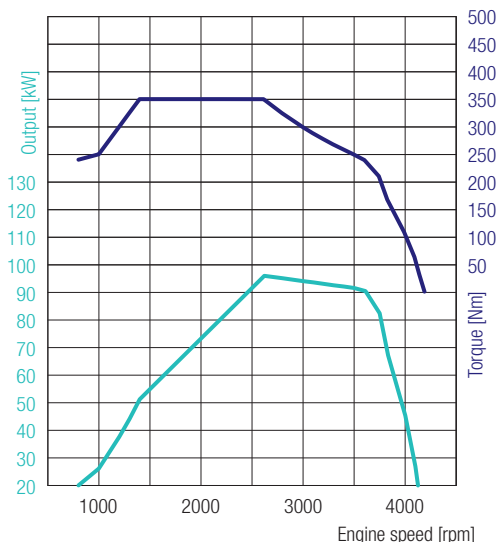

CANTER 3S13

RIGHT-HAND DRIVE

4P10 – 96 kW (130 PS)
 350 Nm@1400 rpm
 96 kW@2620 rpm

ENGINE (EURO VI)

Type	Water-cooled four-stroke diesel engine with turbocharger, intercooler and direct injection		
No. of cylinders	4/in-line		
Capacity	2998 cm ³		
Peak output	96 kW (130 hp) / 2620 rpm		
Rated torque	350 Nm / 1400 rpm		
Diesel particulate filter	Service life approx. 300,000 km		
Alternator	Alternating current 12 V, 140 A		
Exhaust gas aftertreatment	DPF + SCR		
PTO (optional)	Type	31 kW with flange	31 kW for directly connected pumps
	Torque at peak output [Nm]:	196 Nm	
	Gear ratios	1:0.655	1:0.651
	Engine speed at peak output	1500 rpm	

POWERTRAIN

Transmission	Model	Manual gearbox, 5 forward gears, 1 reverse gear
	Gear ratio	5.494 / 3.193 / 1.689 / 1.000 / 0.723 / reverse 5.494
Rear axle gear ratio	Ratio	4.111

CHASSIS

Front axle / rear axle	Model	F100T / R015T
	Load-bearing capacity front/rear	1950 kg / 2500 kg
Tyres		195/75R16C 107/105 R
		Twin tyres at rear
Wheel		16 x 5 JK - 110
Steering		Right-hand drive
		Rack-and-pinion steering with power assist, tilting telescopic steering column with steering-wheel lock
Brake	Service brake	Hydraulic with vacuum power assist, dual-circuit with load-dependent brake proportioning valve at rear wheels
	Front / rear	Disc brake (217 x 24)
	Parking brake	Mechanical expanding brake on drive shaft at rear of transmission
	Auxiliary brake	Exhaust brake (50 kW)
Suspension	Front / rear	Independent wheel suspension (coil spring) with shock absorber / semi-elliptic leaf spring with shock absorber
Frame	Type	Ladder-type frame with reinforcements and crossmembers
Fuel tank capacity		70 litres
Electrical system	Batteries	12 V (100 Ah - 760 A(EN))

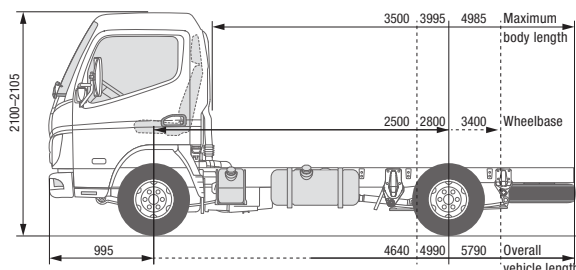
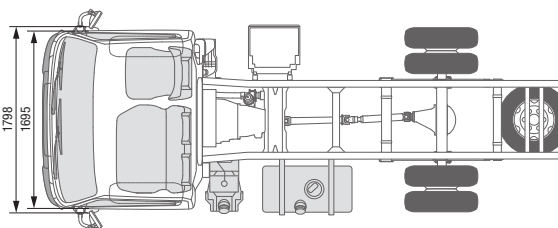

CANTER 3S13 DUONIC® 2.0

RIGHT-HAND DRIVE

MODEL / VEHICLE TYPE 3S13

Cab type / crew	Standard, single cab / 3		
Model variant	46901221	46901321	46901521
FUSO model code	FEA01BR3SEUW	FEA01CR3SEUW	FEA01ER3SEUW

DIMENSIONS [MM]

Wheelbase		2500	2800	3400
Overall length		4640	4990	5790
Cab length			1510	
Width overall			1798	
Cab width			1695	
Height overall		2100		2105
Track width	Front / rear		1405 / 1255	
Frame height (at end of frame)			720	
Ground clearance			165	
Cab to rear axle		1975	2275	2875
Cab to end of frame		3120	3470	4270
Maximum body length**		3500	3995	4985
Frame width			700	
Front overhang			995	
Rear overhang		1145	1195	1395
Front axle to front of body			625	
Recommended distance cab to body			100	

WEIGHTS [KG]

Empty weight*		1960	1970	1990
	Front* / rear*	1440 / 520	1455 / 515	1455 / 535
Minimum vehicle weight		2180		2205
Gross vehicle weight / gross combination weight			3500 / 7000	
Axle loads*	Front / rear		1950 / 2500	
Towed weight	Braked / unbraked		3500 / 750	
Chassis load bearing capacity*		1540	1530	1510

CALCULATED OUTPUT

Maximum speed	km/h		140	
Minimum turning circle [m]	Kerb to kerb	9.0	10.0	11.8
	Wall to wall	10.2	11.2	13.0

* The weight refers to the base vehicle (European series, including coolant, oil, 90% fuel, tyre sealant, tools and driver with 75 kg) without optional equipment. If any optional equipment is added, the weight changes accordingly. ** Calculated maximum value which should be checked depending on the body and application.
 Subject to change without notice. All data is approximate. The illustrations may contain accessories and items of optional equipment which are not part of the standard specification. The data sheet may contain product types and support services not available in certain countries.

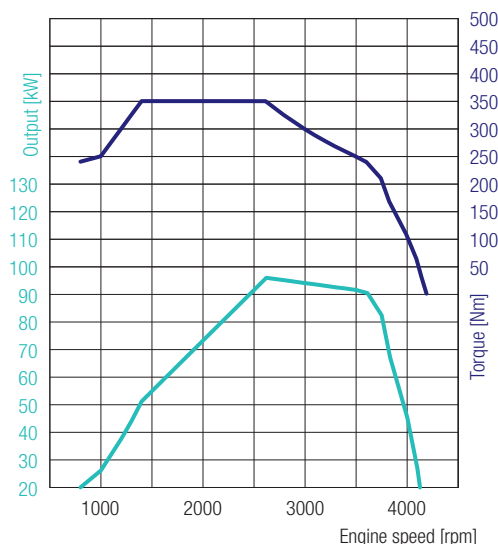

CANTER 3S13 DUONIC® 2.0 RIGHT-HAND DRIVE

4P10 – 96 kW (130 PS)
350 Nm@1400 rpm
96 kW@2620 rpm

ENGINE (EURO VI)

Type	Water-cooled four-stroke diesel engine with turbocharger, intercooler and direct injection		
No. of cylinders	4/in-line		
Capacity	2998 cm ³		
Peak output	96 kW (130 hp) / 2620 rpm		
Rated torque	350 Nm / 1400 rpm		
Diesel particulate filter	Service life approx. 300,000 km		
Alternator	Alternating current 12 V, 140 A		
Exhaust gas aftertreatment	DPF + SCR		
PTO (optional)	Type	31 kW with flange	31 kW for directly connected pumps
	Torque at peak output [Nm]:	196 Nm	
	Gear ratios	1:0.655	1:0.651
	Engine speed at peak output	1500 rpm	

POWERTRAIN

Transmission	Model	DUONIC® 2.0: Automated transmission with dual clutch, 6 forward speeds and 1 reverse gear
	Gear ratio	5.397 / 3.788 / 2.310 / 1.474 / 1.000 / 0.701 / reverse 5.397
Rear axle gear ratio	Ratio	4.111

CHASSIS

Front axle / rear axle	Model	F100T / R015T
	Load-bearing capacity front/rear	1950 kg / 2500 kg
Tyres		195/75R16C 107/105 R
		Twin tyres at rear
Wheel		16 x 5 JK - 110
Steering		Right-hand drive
		Rack-and-pinion steering with power assist, tilting telescopic steering column with steering-wheel lock
Brake	Service brake	Hydraulic with vacuum power assist, dual-circuit with load-dependent brake proportioning valve at rear wheels
	Front / rear	Disc brake (217s24)
	Parking brake	Mechanical expanding brake on drive shaft at rear of transmission
	Auxiliary brake	Exhaust brake (50 kW)
Suspension	Front / rear	Independent wheel suspension (coil spring) with shock absorber / semi-elliptic leaf spring with shock absorber
Frame	Type	Ladder-type frame with reinforcements and crossmembers
Fuel tank capacity		70 litres
Electrical system	Batteries	12 V (100 Ah - 760 A(EN))

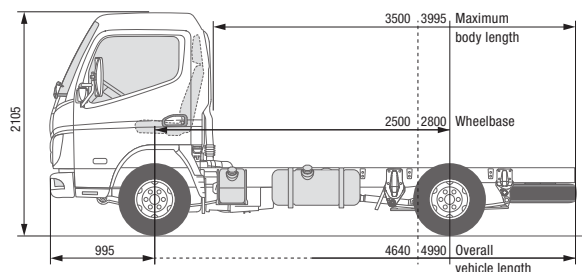
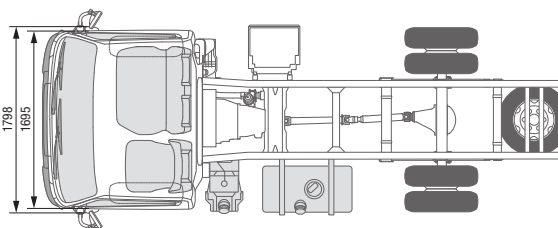

CANTER 3S15

LEFT-HAND DRIVE

MODEL / VEHICLE TYPE	3S15	
----------------------	------	--

Cab type / crew	Standard, single cab / 3	
Model variant	46902211	46902311
FUSO model code	FEA01BL4SEUX	FEA01CL4SEUX

DIMENSIONS [MM]		
-----------------	--	--

Wheelbase		2500	2800
Overall length		4640	4990
Cab length			1510
Width overall			1798
Cab width			1695
Height overall			2105
Track width	Front / rear		1405 / 1255
Frame height (at end of frame)			725
Ground clearance			165
Cab to rear axle		1975	2275
Cab to end of frame		3120	3470
Maximum body length**		3500	3995
Frame width			700
Front overhang			995
Rear overhang		1145	1195
Front axle to front of body			625
Recommended distance cab to body			100

WEIGHTS [KG]		
--------------	--	--

Empty weight*		1940	1950
	Front* / rear*	1420 / 520	1440 / 510
Minimum vehicle weight		2150	2180
Gross vehicle weight / gross combination weight			3500 / 7000
Axle loads*	Front / rear		1950 / 2500
Towed weight	Braked / unbraked		3500 / 750
Chassis load bearing capacity*		1560	1550

CALCULATED OUTPUT		
-------------------	--	--

Maximum speed	km/h		145
Minimum turning circle [m]	Kerb to kerb	9.0	10.0
	Wall to wall	10.2	11.2

* The weight refers to the base vehicle (European series, including coolant, oil, 90% fuel, tyre sealant, tools and driver with 75 kg) without optional equipment. If any optional equipment is added, the weight changes accordingly. ** Calculated maximum value which should be checked depending on the body and application.
 Subject to change without notice. All data is approximate. The illustrations may contain accessories and items of optional equipment which are not part of the standard specification. The data sheet may contain product types and support services not available in certain countries.

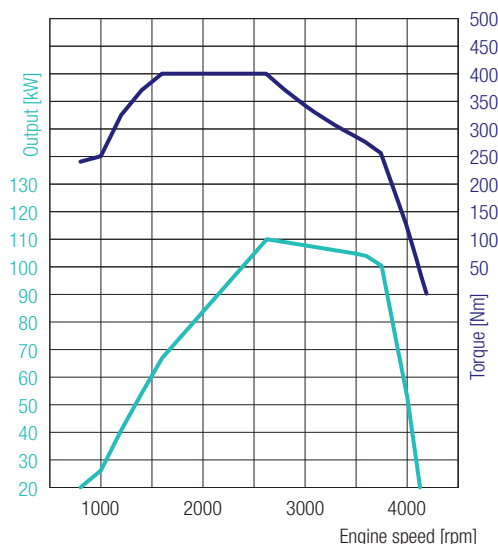

4P10 – 110 kW (150 PS)
 400 Nm@1600 rpm
 110 kW@2626 rpm

CANTER 3S15

LEFT-HAND DRIVE

ENGINE (EURO VI)

Type	Water-cooled four-stroke diesel engine with turbocharger, intercooler and direct injection		
No. of cylinders	4/in-line		
Capacity	2998 cm ³		
Peak output	110 kW (150 hp) / 2626 rpm		
Rated torque	400 Nm / 1600 rpm		
Diesel particulate filter	Service life approx. 300,000 km		
Alternator	Alternating current 12 V, 140 A		
Exhaust gas aftertreatment	DPF + SCR		
PTO (optional)	Type	31 kW with flange	31 kW for directly connected pumps
	Torque at peak output [Nm]:	196 Nm	
	Gear ratios	1:0.644	1:0.638
	Engine speed at peak output	1500 rpm	

POWERTRAIN

Transmission	Model	Manual gearbox, 5 forward gears, 1 reverse gear
	Gear ratio	5.494 / 3.193 / 1.689 / 1.000 / 0.723 / reverse 5.494
Rear axle gear ratio	Ratio	4.111

CHASSIS

Front axle / rear axle	Model	F100T / R015T
	Load-bearing capacity front/rear	1950 kg / 2500 kg
Tyres		195/75R16C 107/105 R
		Twin tyres at rear
Wheel		16 x 5 JK - 110
Steering		Left-hand drive
		Rack-and-pinion steering with power assist, tilting telescopic steering column with steering-wheel lock
Brake	Service brake	Hydraulic with vacuum power assist, dual-circuit with load-dependent brake proportioning valve at rear wheels
	Front / rear	Disc brake (217 x 24)
	Parking brake	Mechanical expanding brake on drive shaft at rear of transmission
	Auxiliary brake	Exhaust brake (50 kW)
Suspension	Front / rear	Independent wheel suspension (coil spring) with shock absorber / semi-elliptic leaf spring with shock absorber
Frame	Type	Ladder-type frame with reinforcements and crossmembers
Fuel tank capacity		70 litres
Electrical system	Batteries	12 V (100 Ah - 760 A(EN))

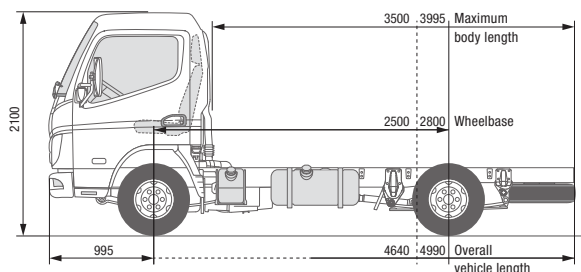
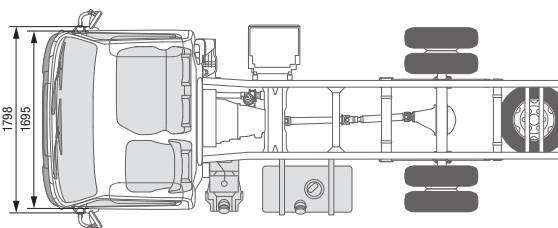

CANTER 3S15 DUONIC® 2.0

LEFT-HAND DRIVE

MODEL / VEHICLE TYPE		3S15	
Cab type / crew		Standard, single cab / 3	
Model variant		46903211	46903311
FUSO model code		FEA01BL3SEUX	FEA01CL3SEUX
DIMENSIONS [MM]			
Wheelbase		2500	2800
Overall length		4640	4990
Cab length		1510	
Width overall		1798	
Cab width		1695	
Height overall		2100	
Track width		Front / rear 1405 / 1255	
Frame height (at end of frame)		730	725
Ground clearance		165	
Cab to rear axle		1975	2275
Cab to end of frame		3120	3470
Maximum body length**		3500	3995
Frame width		700	
Front overhang		995	
Rear overhang		1145	1195
Front axle to front of body		625	
Recommended distance cab to body		100	
WEIGHTS [KG]			
Empty weight*		1960	1970
Front* / rear*		1440 / 520	1455 / 515
Minimum vehicle weight		2180	2205
Gross vehicle weight / gross combination weight		3500 / 7000	
Axle loads*		Front / rear 1950 / 2500	
Towed weight		Braked / unbraked 3500 / 750	
Chassis load bearing capacity*		1540	1530
CALCULATED OUTPUT			
Maximum speed		km/h	145
Minimum turning circle [m]		Kerb to kerb	9.0
		Wall to wall	10.2

* The weight refers to the base vehicle (European series, including coolant, oil, 90% fuel, tyre sealant, tools and driver with 75 kg) without optional equipment. If any optional equipment is added, the weight changes accordingly. ** Calculated maximum value which should be checked depending on the body and application. Subject to change without notice. All data is approximate. The illustrations may contain accessories and items of optional equipment which are not part of the standard specification. The data sheet may contain product types and support services not available in certain countries.

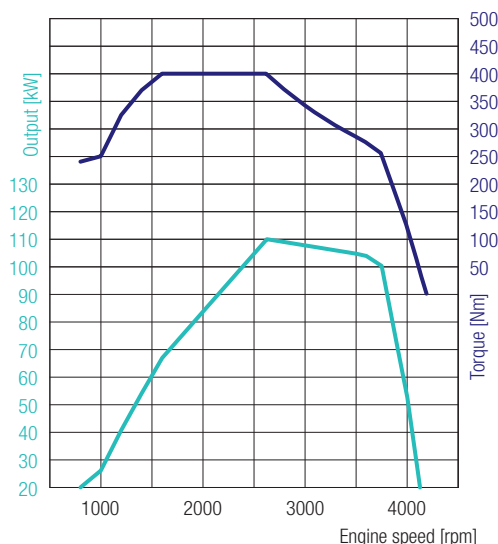

4P10 – 110 kW (150 PS)
 400 Nm@1600 rpm
 110 kW@2626 rpm

CANTER 3S15 DUONIC® 2.0 LEFT-HAND DRIVE

ENGINE (EURO VI)

Type	Water-cooled four-stroke diesel engine with turbocharger, intercooler and direct injection		
No. of cylinders	4/in-line		
Capacity	2998 cm ³		
Peak output	110 kW (150 hp) / 2626 rpm		
Rated torque	400 Nm / 1600 rpm		
Diesel particulate filter	Service life approx. 300,000 km		
Alternator	Alternating current 12 V, 140 A		
Exhaust gas aftertreatment	DPF + SCR		
PTO (optional)	Type	31 kW with flange	31 kW for directly connected pumps
	Torque at peak output [Nm]:	196 Nm	
	Gear ratios	1:0.655	1:0.651
	Engine speed at peak output	1500 rpm	

POWERTRAIN

Transmission	Model	DUONIC® 2.0: Automated transmission with dual clutch, 6 forward speeds and 1 reverse gear
	Gear ratio	5.397 / 3.788 / 2.310 / 1.474 / 1.000 / 0.701 / reverse 5.397
Rear axle gear ratio	Ratio	4.111

CHASSIS

Front axle / rear axle	Model	F100T / R015T
	Load-bearing capacity front/rear	1950 kg / 2500 kg
Tyres		195/75R16C 107/105 R
		Twin tyres at rear
Wheel		16 x 5 JK - 110
Steering		Left-hand drive
		Rack-and-pinion steering with power assist, tilting telescopic steering column with steering-wheel lock
Brake	Service brake	Hydraulic with vacuum power assist, dual-circuit with load-dependent brake proportioning valve at rear wheels
	Front / rear	Disc brake (217 x 24)
	Parking brake	Mechanical expanding brake on drive shaft at rear of transmission
	Auxiliary brake	Exhaust brake (50 kW)
Suspension	Front / rear	Independent wheel suspension (coil spring) with shock absorber / semi-elliptic leaf spring with shock absorber
Frame	Type	Ladder-type frame with reinforcements and crossmembers
Fuel tank capacity		70 litres
Electrical system	Batteries	12 V (100 Ah - 760 A(EN))

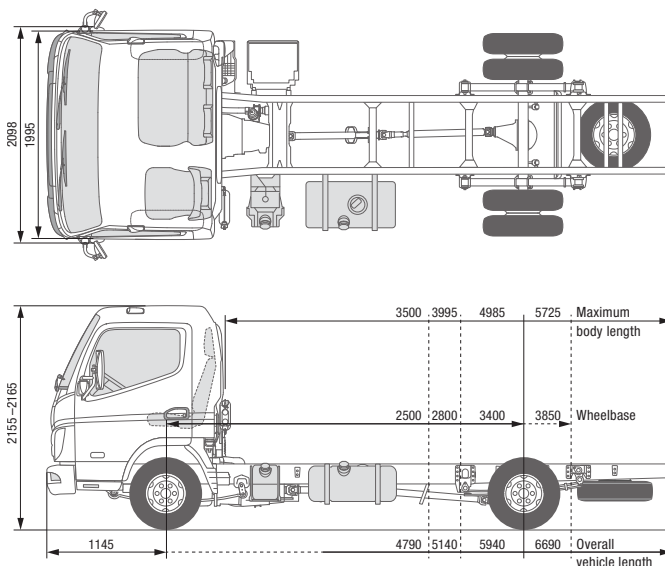

CANTER 3C13

LEFT-HAND DRIVE

MODEL / VEHICLE TYPE 3C13

Cab type / crew	Comfort, single cab / 3			
Model variant	46904211	46904311	46904511	46904711
FUSO model code	FEB01BL4SEUW	FEB01CL4SEUW	FEB01EL4SEUW	FEB01GL4SEUW

DIMENSIONS [MM]

Wheelbase		2500	2800	3400	3850
Overall length		4790	5140	5940	6690
Cab length		1625			
Width overall		2098			
Cab width		1995			
Height overall		2165	2160	2160	2155
Track width	Front / rear	1665 / 1500			
Frame height (at end of frame)		740		765	
Ground clearance		165			
Cab to rear axle		1975	2275	2875	3325
Cab to end of frame		3120	3470	4270	5020
Maximum body length**		3500	3995	4985	5725
Frame width		750			
Front overhang		1145			
Rear overhang		1145	1195	1395	1695
Front axle to front of body		625			
Recommended distance cab to body		100			

WEIGHTS [KG]

Empty weight*		2040	2050	2070	2090
	Front* / rear*	1510 / 530	1525 / 525	1530 / 540	1550 / 540
Minimum vehicle weight		2290	2310	2315	2345
Gross vehicle weight / gross combination weight		3500 / 7000			
Axle loads*	Front / rear	1950 / 2500			
Towed weight	Braked / unbraked	3500 / 750			
Chassis load bearing capacity*		1460	1450	1430	1410

CALCULATED OUTPUT

Maximum speed	km/h	132			
Minimum turning circle [m]	Kerb to kerb	8.6	9.4	11.2	12.4
	Wall to wall	10.0	11.0	12.6	14.0

* The weight refers to the base vehicle (European series, including coolant, oil, 90% fuel, tyre sealant, tools and driver with 75 kg) without optional equipment. If any optional equipment is added, the weight changes accordingly. ** Calculated maximum value which should be checked depending on the body and application. Subject to change without notice. All data is approximate. The illustrations may contain accessories and items of optional equipment which are not part of the standard specification. The data sheet may contain product types and support services not available in certain countries.

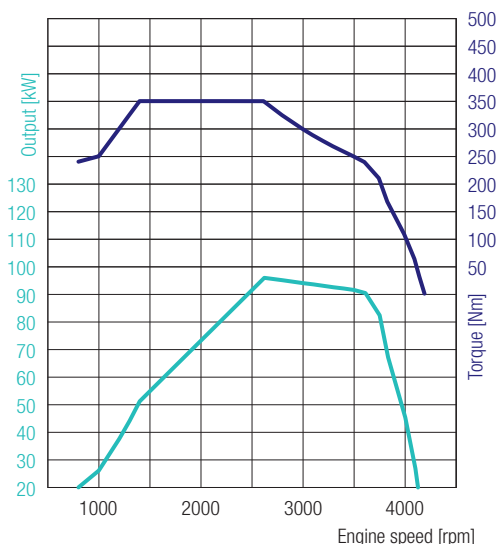

4P10 – 96 kW (130 PS)
 350 Nm@1400 rpm
 96 kW@2620 rpm

CANTER 3C13

LEFT-HAND DRIVE

ENGINE (EURO VI)

Type	Water-cooled four-stroke diesel engine with turbocharger, intercooler and direct injection		
No. of cylinders	4/in-line		
Capacity	2998 cm ³		
Peak output	96 kW (130 hp) / 2620 rpm		
Rated torque	350 Nm / 1400 rpm		
Diesel particulate filter	Service life approx. 300,000 km		
Alternator	Alternating current 12 V, 140 A		
Exhaust gas aftertreatment	DPF + SCR		
PTO (optional)	Type	31 kW with flange	31 kW for directly connected pumps
	Torque at peak output [Nm]:	196 Nm	
	Gear ratios	1:0.644	1:0.638
	Engine speed at peak output	1500 rpm	

POWERTRAIN

Transmission	Model	Manual gearbox, 5 forward gears, 1 reverse gear
	Gear ratio	5.494 / 3.193 / 1.689 / 1.000 / 0.723 / reverse 5.494
Rear axle gear ratio	Ratio	4.111

CHASSIS

Front axle / rear axle	Model	F100T / R015T
	Load-bearing capacity front/rear	1950 kg / 2500 kg
Tyres		195/75R16C 107/105 R
		Twin tyres at rear
Wheel		16 x 5 JK - 110
Steering		Left-hand drive
		Rack-and-pinion steering with power assist, tilting telescopic steering column with steering-wheel lock
Brake	Service brake	Hydraulic with vacuum power assist, dual-circuit with load-dependent brake proportioning valve at rear wheels
	Front / rear	Disc brake (217 x 24)
	Parking brake	Mechanical expanding brake on drive shaft at rear of transmission
	Auxiliary brake	Exhaust brake (50 kW)
Suspension	Front / rear	Independent wheel suspension (coil spring) with shock absorber/ semi-elliptic leaf spring with shock absorber and stabiliser
Frame	Type	Ladder-type frame with reinforcements and crossmembers
Fuel tank capacity		70 litres
Electrical system	Batteries	12 V (100 Ah - 760 A(EN))

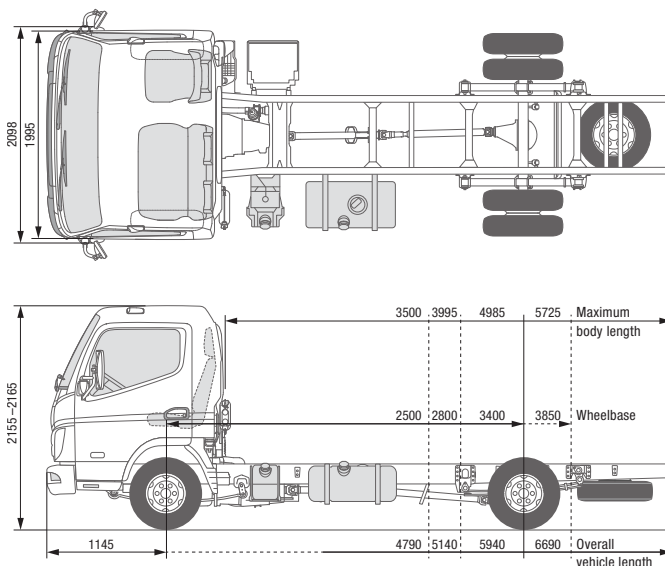

CANTER 3C13 RIGHT-HAND DRIVE

MODEL / VEHICLE TYPE 3C13

Cab type / crew	Comfort, single cab / 3			
Model variant	46904221	46904321	46904521	46904721
FUSO model code	FEB01BR4SEUW	FEB01CR4SEUW	FEB01ER4SEUW	FEB01GR4SEUW

DIMENSIONS [MM]

Wheelbase	2500	2800	3400	3850
Overall length	4790	5140	5940	6690
Cab length	1625			
Width overall	2098			
Cab width	1995			
Height overall	2165	2160	2160	2155
Track width	Front / rear		1665 / 1500	
Frame height (at end of frame)	750			
Ground clearance	165			
Cab to rear axle	1975	2275	2875	3325
Cab to end of frame	3120	3470	4270	5020
Maximum body length**	3500	3995	4985	5725
Frame width	750			
Front overhang	1145			
Rear overhang	1145	1195	1395	1695
Front axle to front of body	625			
Recommended distance cab to body	100			

WEIGHTS [KG]

Empty weight*		2040	2050	2070	2090
	Front* / rear*	1510 / 530	1525 / 525	1530 / 540	1550 / 540
Minimum vehicle weight		2290	2310	2315	2345
Gross vehicle weight / gross combination weight		3500 / 7000			
Axle loads*	Front / rear	1950 / 2500			
Towed weight	Braked / unbraked	3500 / 750			
Chassis load bearing capacity*		1460	1450	1430	1410

CALCULATED OUTPUT

Maximum speed	km/h	132			
Minimum turning circle [m]	Kerb to kerb	8.6	9.4	11.2	12.4
	Wall to wall	10.0	11.0	12.6	14.0

* The weight refers to the base vehicle (European series, including coolant, oil, 90% fuel, tyre sealant, tools and driver with 75 kg) without optional equipment. If any optional equipment is added, the weight changes accordingly. ** Calculated maximum value which should be checked depending on the body and application.
Subject to change without notice. All data is approximate. The illustrations may contain accessories and items of optional equipment which are not part of the standard specification. The data sheet may contain product types and support services not available in certain countries.

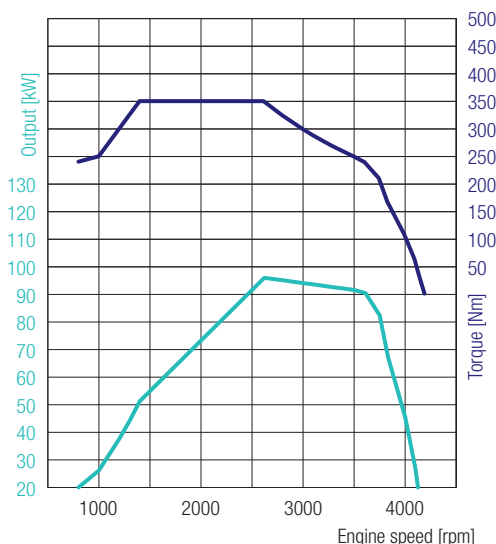

4P10 – 96 kW (130 PS)
 350 Nm@1400 rpm
 96 kW@2620 rpm

CANTER 3C13

RIGHT-HAND DRIVE

ENGINE (EURO VI)

Type	Water-cooled four-stroke diesel engine with turbocharger, intercooler and direct injection		
No. of cylinders	4/in-line		
Capacity	2998 cm ³		
Peak output	96 kW (130 hp) / 2620 rpm		
Rated torque	350 Nm / 1400 rpm		
Diesel particulate filter	Service life approx. 300,000 km		
Alternator	Alternating current 12 V, 140 A		
Exhaust gas aftertreatment	DPF + SCR		
PTO (optional)	Type	31 kW with flange	31 kW for directly connected pumps
	Torque at peak output [Nm]:	196 Nm	
	Gear ratios	1:0.644	1:0.638
	Engine speed at peak output	1500 rpm	

POWERTRAIN

Transmission	Model	Manual gearbox, 5 forward gears, 1 reverse gear
	Gear ratio	5.494 / 3.193 / 1.689 / 1.000 / 0.723 / reverse 5.494
Rear axle gear ratio	Ratio	4.111

CHASSIS

Front axle / rear axle	Model	F100T / R015T
	Load-bearing capacity front/rear	1950 kg / 2500 kg
Tyres		195/75R16C 107/105 R
		Twin tyres at rear
Wheel		16 x 5 JK - 110
Steering		Right-hand drive
		Rack-and-pinion steering with power assist, tilting telescopic steering column with steering-wheel lock
Brake	Service brake	Hydraulic with vacuum power assist, dual-circuit with load-dependent brake proportioning valve at rear wheels
	Front / rear	Disc brake (217 x 24)
	Parking brake	Mechanical expanding brake on drive shaft at rear of transmission
	Auxiliary brake	Exhaust brake (50 kW)
Suspension	Front / rear	Independent wheel suspension (coil spring) with shock absorber / semi-elliptic leaf spring with shock absorber and stabiliser
Frame	Type	Ladder-type frame with reinforcements and crossmembers
Fuel tank capacity		70 litres
Electrical system	Batteries	12 V (100 Ah - 760 A(EN))

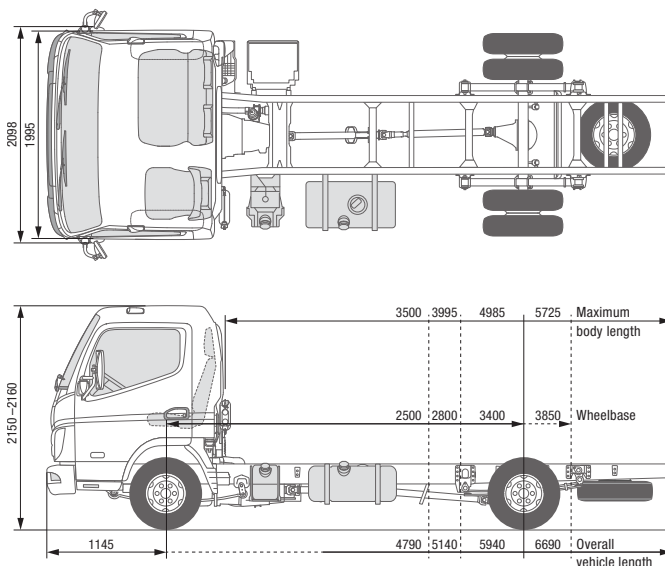

CANTER 3C13 DUONIC® 2.0 LEFT-HAND DRIVE

MODEL / VEHICLE TYPE 3C13

Cab type / crew	Comfort, single cab / 3			
Model variant	46905211	46905311	46905511	46905711
FUSO model code	FEB01BL3SEUW	FEB01CL3SEUW	FEB01EL3SEUW	FEB01GL3SEUW

DIMENSIONS [MM]

Wheelbase	2500	2800	3400	3850
Overall length	4790	5140	5940	6690
Cab length	1625			
Width overall	2098			
Cab width	1995			
Height overall	2160	2155	2155	2150
Track width	Front / rear		1665 / 1500	
Frame height (at end of frame)	745		765	770
Ground clearance	165			
Cab to rear axle	1975	2275	2875	3325
Cab to end of frame	3120	3470	4270	5020
Maximum body length**	3500	3995	4985	5725
Frame width	750			
Front overhang	1145			
Rear overhang	1145	1195	1395	1695
Front axle to front of body	625			
Recommended distance cab to body	100			

WEIGHTS [KG]

Empty weight*		2060	2070	2095	2110
	Front* / rear*	1525 / 535	1540 / 530	1550 / 545	1565 / 545
Minimum vehicle weight		2310	2335	2350	2370
Gross vehicle weight / gross combination weight		3500 / 7000			
Axle loads*	Front / rear	1950 / 2500			
Towed weight	Braked / unbraked	3500 / 750			
Chassis load bearing capacity*		1440	1430	1405	1390

CALCULATED OUTPUT

Maximum speed	km/h	131			
Minimum turning circle [m]	Kerb to kerb	8.6	9.4	11.2	12.4
	Wall to wall	10.0	11.0	12.6	14.0

* The weight refers to the base vehicle (European series, including coolant, oil, 90% fuel, tyre sealant, tools and driver with 75 kg) without optional equipment. If any optional equipment is added, the weight changes accordingly. ** Calculated maximum value which should be checked depending on the body and application.
Subject to change without notice. All data is approximate. The illustrations may contain accessories and items of optional equipment which are not part of the standard specification. The data sheet may contain product types and support services not available in certain countries.

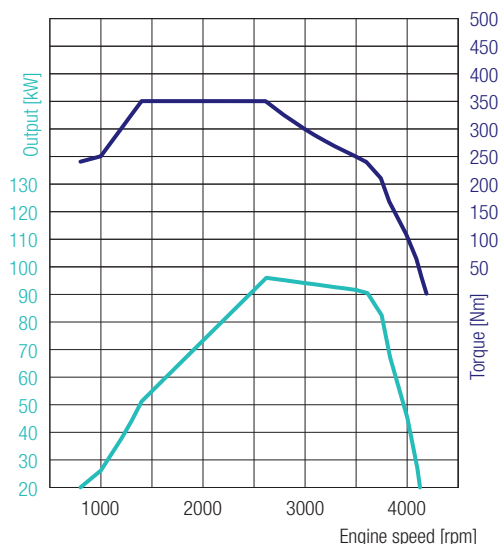

CANTER 3C13 DUONIC® 2.0 LEFT-HAND DRIVE

4P10 – 96 kW (130 PS)
350 Nm@1400 rpm
96 kW@2620 rpm

ENGINE (EURO VI)

Type	Water-cooled four-stroke diesel engine with turbocharger, intercooler and direct injection		
No. of cylinders	4/in-line		
Capacity	2998 cm ³		
Peak output	96 kW (130 hp) / 2620 rpm		
Rated torque	350 Nm / 1400 rpm		
Diesel particulate filter	Service life approx. 300,000 km		
Alternator	Alternating current 12 V, 140 A		
Exhaust gas aftertreatment	DPF + SCR		
PTO (optional)	Type	31 kW with flange	31 kW for directly connected pumps
	Torque at peak output [Nm]:	196 Nm	
	Gear ratios	1:0.655	1:0.651
	Engine speed at peak output	1500 rpm	

POWERTRAIN

Transmission	Type	DUONIC® 2.0: Automated transmission with dual clutch, 6 forward speeds and 1 reverse gear	
	Gear ratio	5.397 / 3.788 / 2.310 / 1.474 / 1.000 / 0.701 / reverse 5.397	
Rear axle gear ratio	Ratio	4.111	

CHASSIS

Front axle / rear axle	Model	F100T / R015T	
	Load-bearing capacity front/rear	1950 kg / 2500 kg	
Tyres		195/75R16C 107/105 R	
		Twin tyres at rear	
Wheel		16 x 5 JK - 110	
Steering		Left-hand drive	
		Rack-and-pinion steering with power assist, tilting telescopic steering column with steering-wheel lock	
Brake	Service brake	Hydraulic with vacuum power assist, dual-circuit with load-dependent brake proportioning valve at rear wheels	
	Front / rear	Disc brake (217 x 24)	
	Parking brake	Mechanical expanding brake on drive shaft at rear of transmission	
	Auxiliary brake	Exhaust brake (50 kW)	
Suspension	Front / rear	Independent wheel suspension (coil spring) with shock absorber / semi-elliptic leaf spring with shock absorber and stabiliser	
Frame	Type	Ladder-type frame with reinforcements and crossmembers	
Fuel tank capacity		70 litres	
Electrical system	Batteries	12 V (100 Ah - 760 A(EN))	

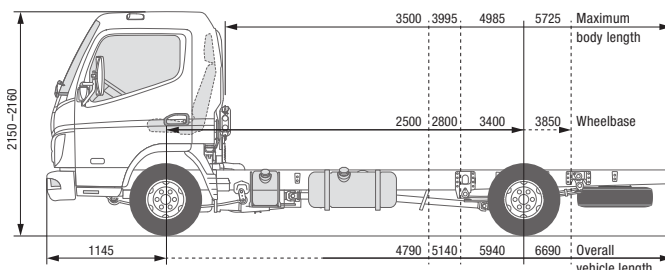
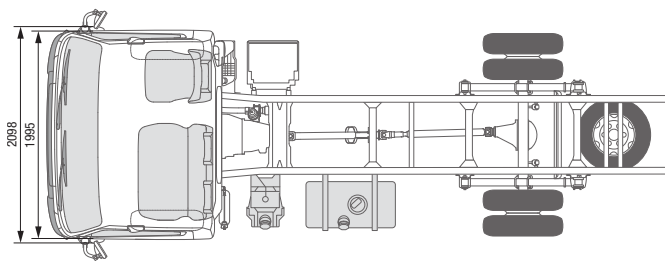

CANTER 3C13 DUONIC® 2.0

RIGHT-HAND DRIVE

MODEL / VEHICLE TYPE 3C13

Cab type / crew	Comfort, single cab / 3			
Model variant	46905221	46905321	46905521	46905721
FUSO model code	FEB01BR3SEUW	FEB01CR3SEUW	FEB01ER3SEUW	FEB01GR3SEUW

DIMENSIONS [MM]

Wheelbase	2500	2800	3400	3850
Overall length	4790	5140	5940	6690
Cab length	1625			
Width overall	2098			
Cab width	1995			
Height overall	2160	2155	2155	2150
Track width	Front / rear		1665 / 1500	
Frame height (at end of frame)	745		765	770
Ground clearance	165			
Cab to rear axle	1975	2275	2875	3325
Cab to end of frame	3120	3470	4270	5020
Maximum body length**	3500	3995	4985	5725
Frame width	750			
Front overhang	1145			
Rear overhang	1145	1195	1395	1695
Front axle to front of body	625			
Recommended distance cab to body	100			

WEIGHTS [KG]

Empty weight*		2060	2070	2095	2110
	Front* / rear*	1525 / 535	1540 / 530	1550 / 545	1565 / 545
Minimum vehicle weight		2310	2335	2350	2370
Gross vehicle weight / gross combination weight		3500 / 7000			
Axle loads*	Front / rear	1950 / 2500			
Towed weight	Braked / unbraked	3500 / 750			
Chassis load bearing capacity*		1440	1430	1405	1390

CALCULATED OUTPUT

Maximum speed	km/h	131			
Minimum turning circle [m]	Kerb to kerb	8.6	9.4	11.2	12.4
	Wall to wall	10.0	11.0	12.6	14.0

* The weight refers to the base vehicle (European series, including coolant, oil, 90% fuel, tyre sealant, tools and driver with 75 kg) without optional equipment. If any optional equipment is added, the weight changes accordingly. ** Calculated maximum value which should be checked depending on the body and application. Subject to change without notice. All data is approximate. The illustrations may contain accessories and items of optional equipment which are not part of the standard specification. The data sheet may contain product types and support services not available in certain countries.

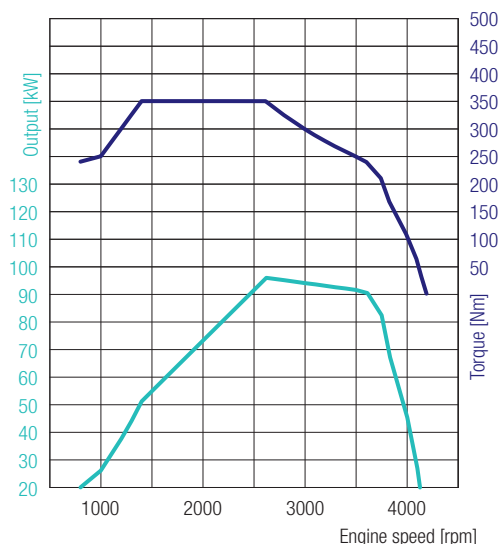

CANTER 3C13 DUONIC® 2.0 RIGHT-HAND DRIVE

4P10 – 96 kW (130 PS)
350 Nm@1400 rpm
96 kW@2620 rpm

ENGINE (EURO VI)

Type	Water-cooled four-stroke diesel engine with turbocharger, intercooler and direct injection		
No. of cylinders	4/in-line		
Capacity	2998 cm ³		
Peak output	96 kW (130 hp) / 2620 rpm		
Rated torque	350 Nm / 1400 rpm		
Diesel particulate filter	Service life approx. 300,000 km		
Alternator	Alternating current 12 V, 140 A		
Exhaust gas aftertreatment	DPF + SCR		
PTO (optional)	Type	31 kW with flange	31 kW for directly connected pumps
	Torque at peak output [Nm]:	196 Nm	
	Gear ratios	1:0.655	1:0.651
	Engine speed at peak output	1500 rpm	

POWERTRAIN

Transmission	Model	DUONIC® 2.0: Automated transmission with dual clutch, 6 forward speeds and 1 reverse gear	
	Gear ratio	5.397 / 3.788 / 2.310 / 1.474 / 1.000 / 0.701 / reverse 5.397	
Rear axle gear ratio	Ratio	4.111	

CHASSIS

Front axle / rear axle	Model	F100T / R015T	
	Load-bearing capacity front/rear	1950 kg / 2500 kg	
Tyres		195/75R16C 107/105 R	
		Twin tyres at rear	
Wheel		16 x 5 JK - 110	
Steering		Right-hand drive	
		Rack-and-pinion steering with power assist, tilting telescopic steering column with steering-wheel lock	
Brake	Service brake	Hydraulic with vacuum power assist, dual-circuit with load-dependent brake proportioning valve at rear wheels	
	Front / rear	Disc brake (217 x 24)	
	Parking brake	Mechanical expanding brake on drive shaft at rear of transmission	
	Auxiliary brake	Exhaust brake (50 kW)	
Suspension	Front / rear	Independent wheel suspension (coil spring) with shock absorber / semi-elliptic leaf spring with shock absorber and stabiliser	
Frame	Type	Ladder-type frame with reinforcements and crossmembers	
Fuel tank capacity		70 litres	
Electrical system	Batteries	12 V (100 Ah - 760 A(EN))	

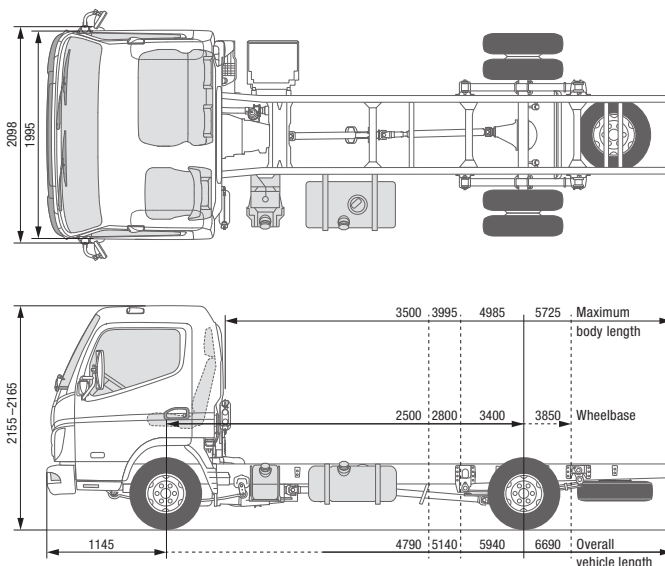

CANTER 3C15

LEFT-HAND DRIVE

MODEL / VEHICLE TYPE 3C15

Cab type / crew	Comfort, single cab / 3			
Model variant	46906211	46906311	46906511	46906711
FUSO model code	FEB01BL4SEUX	FEB01CL4SEUX	FEB01EL4SEUX	FEB01GL4SEUX

DIMENSIONS [MM]

Wheelbase		2500	2800	3400	3850
Overall length		4790	5140	5940	6690
Cab length		1625			
Width overall		2098			
Cab width		1995			
Height overall		2165	2160	2160	2155
Track width	Front / rear	1665 / 1500			
Frame height (at end of frame)		740		765	
Ground clearance		165			
Cab to rear axle		1975	2275	2875	3325
Cab to end of frame		3120	3470	4270	5020
Maximum body length**		3500	3995	4985	5725
Frame width		750			
Front overhang		1145			
Rear overhang		1145	1195	1395	1695
Front axle to front of body		625			
Recommended distance cab to body		100			

WEIGHTS [KG]

Empty weight*		2040	2050	2070	2090
	Front* / rear*	1510 / 530	1525 / 525	1530 / 540	1550 / 540
Minimum vehicle weight		2290	2310	2315	2345
Gross vehicle weight / gross combination weight		3500 / 7000			
Axle loads*	Front / rear	1950 / 2500			
Towed weight	Braked / unbraked	3500 / 750			
Chassis load bearing capacity*		1460	1450	1430	1410

CALCULATED OUTPUT

Maximum speed	km/h	136			
Minimum turning circle [m]	Kerb to kerb	8.6	9.4	11.2	12.4
	Wall to wall	10.0	11.0	12.6	14.0

* The weight refers to the base vehicle (European series, including coolant, oil, 90% fuel, tyre sealant, tools and driver with 75 kg) without optional equipment. If any optional equipment is added, the weight changes accordingly. ** Calculated maximum value which should be checked depending on the body and application. Subject to change without notice. All data is approximate. The illustrations may contain accessories and items of optional equipment which are not part of the standard specification. The data sheet may contain product types and support services not available in certain countries.

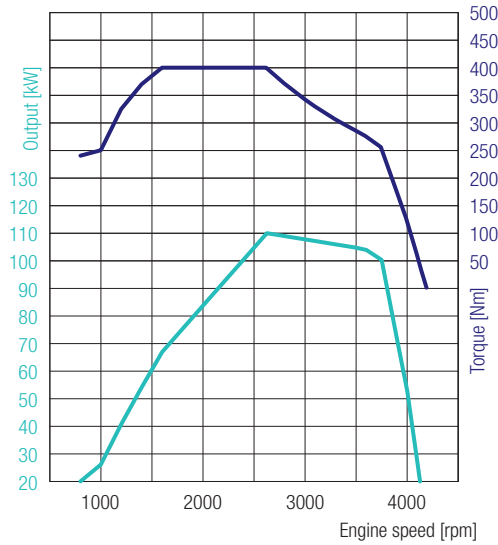

4P10 – 110 kW (150 PS)
 400 Nm@1600 rpm
 110 kW@2626 rpm

CANTER 3C15 LEFT-HAND DRIVE

ENGINE (EURO VI)

Type	Water-cooled four-stroke diesel engine with turbocharger, intercooler and direct injection		
No. of cylinders	4/in-line		
Capacity	2998 cm ³		
Peak output	110 kW (150 hp) / 2626 rpm		
Rated torque	400 Nm / 1600 rpm		
Diesel particulate filter	Service life approx. 300,000 km		
Alternator	Alternating current 12 V, 140 A		
Exhaust gas aftertreatment	DPF + SCR		
PTO (optional)	Type	31 kW with flange	31 kW for directly connected pumps
	Torque at peak output [Nm]:	196 Nm	
	Gear ratios	1:0.644	1:0.638
	Engine speed at peak output	1500 rpm	

POWERTRAIN

Transmission	Model	Manual gearbox, 5 forward gears, 1 reverse gear
	Gear ratio	5.494 / 3.193 / 1.689 / 1.000 / 0.723 / reverse 5.494
Rear axle gear ratio	Ratio	4.111

CHASSIS

Front axle / rear axle	Model	F100T / R015T
	Load-bearing capacity front/rear	1950 kg / 2500 kg
Tyres		195/75R16C 107/105 R
		Twin tyres at rear
Wheel		16 x 5 JK - 110
Steering		Left-hand drive
		Rack-and-pinion steering with power assist, tilting telescopic steering column with steering-wheel lock
Brake	Service brake	Hydraulic with vacuum power assist, dual-circuit with load-dependent brake proportioning valve at rear wheels
	Front / rear	Disc brake (217 x 24)
	Parking brake	Mechanical expanding brake on drive shaft at rear of transmission
	Auxiliary brake	Exhaust brake (50 kW)
Suspension	Front / rear	Independent wheel suspension (coil spring) with shock absorber / semi-elliptic leaf spring with shock absorber and stabiliser
Frame	Type	Ladder-type frame with reinforcements and crossmembers
Fuel tank capacity		70 litres
Electrical system	Batteries	12 V (100 Ah - 760 A(EN))

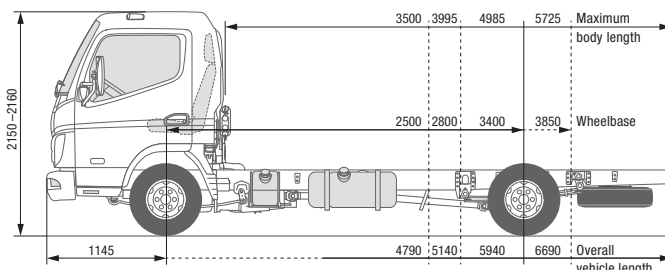
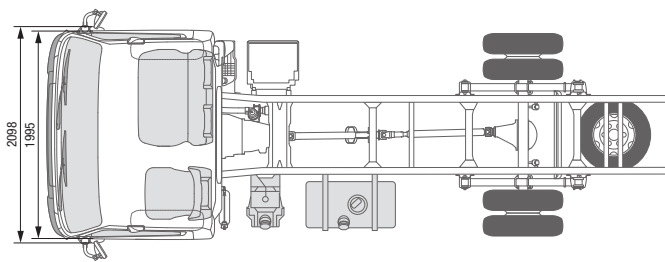

CANTER 3C15 DUONIC® 2.0

LEFT-HAND DRIVE

MODEL / VEHICLE TYPE 3C15

Cab type / crew	Comfort, single cab / 3			
Model variant	46907211	46907311	46907511	46907711
FUSO model code	FEB01BL3SEUX	FEB01CL3SEUX	FEB01EL3SEUX	FEB01GL3SEUX

DIMENSIONS [MM]

Wheelbase	2500	2800	3400	3850
Overall length	4790	5140	5940	6690
Cab length	1625			
Width overall	2098			
Cab width	1995			
Height overall	2160	2155	2155	2150
Track width	Front / rear		1665 / 1500	
Frame height (at end of frame)	745		765	770
Ground clearance	165			
Cab to rear axle	1975	2275	2875	3325
Cab to end of frame	3120	3470	4270	5020
Maximum body length**	3500	3995	4985	5725
Frame width	750			
Front overhang	1145			
Rear overhang	1145	1195	1395	1695
Front axle to front of body	625			
Recommended distance cab to body	100			

WEIGHTS [KG]

Empty weight*		2060	2070	2095	2110
	Front* / rear*	1525 / 535	1540 / 530	1550 / 545	1565 / 545
Minimum vehicle weight		2310	2335	2350	2370
Gross vehicle weight / gross combination weight		3500 / 7000			
Axle loads*	Front / rear	1950 / 2500			
Towed weight	Braked / unbraked	3500 / 750			
Chassis load bearing capacity*		1440	1430	1405	1390

CALCULATED OUTPUT

Maximum speed	km/h	137			
Minimum turning circle [m]	Kerb to kerb	8.6	9.4	11.2	12.4
	Wall to wall	10.0	11.0	12.6	14.0

* The weight refers to the base vehicle (European series, including coolant, oil, 90% fuel, tyre sealant, tools and driver with 75 kg) without optional equipment. If any optional equipment is added, the weight changes accordingly. ** Calculated maximum value which should be checked depending on the body and application.
Subject to change without notice. All data is approximate. The illustrations may contain accessories and items of optional equipment which are not part of the standard specification. The data sheet may contain product types and support services not available in certain countries.

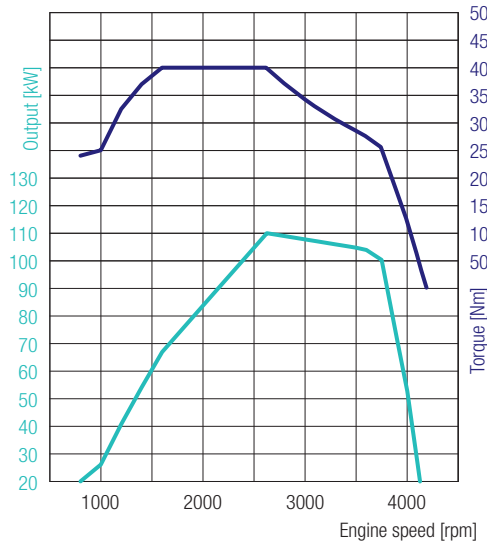

CANTER 3C15 DUONIC® 2.0 LEFT-HAND DRIVE

4P10 – 110 kW (150 PS)
400 Nm@1600 rpm
110 kW@2626 rpm

ENGINE (EURO VI)

Type	Water-cooled four-stroke diesel engine with turbocharger, intercooler and direct injection		
No. of cylinders	4/in-line		
Capacity	2998 cm ³		
Peak output	110 kW (150 hp) / 2626 rpm		
Rated torque	400 Nm / 1600 rpm		
Diesel particulate filter	Service life approx. 300,000 km		
Alternator	Alternating current 12 V, 140 A		
Exhaust gas aftertreatment	DPF + SCR		
PTO (optional)	Type	31 kW with flange	31 kW for directly connected pumps
	Torque at peak output [Nm]:	196 Nm	
	Gear ratios	1:0.655	1:0.651
	Engine speed at peak output	1500 rpm	

POWERTRAIN

Transmission	Model	DUONIC® 2.0: Automated transmission with dual clutch, 6 forward speeds and 1 reverse gear
	Gear ratio	5.397 / 3.788 / 2.310 / 1.474 / 1.000 / 0.701 / reverse 5.397
Rear axle gear ratio	Ratio	4.111

CHASSIS

Front axle / rear axle	Model	F100T / R015T
	Load-bearing capacity front/rear	1950 kg / 2500 kg
Tyres		195/75R16C 107/105 R
		Twin tyres at rear
Wheel		16 x 5 JK - 110
Steering		Left-hand drive
		Rack-and-pinion steering with power assist, tilting telescopic steering column with steering-wheel lock
Brake	Service brake	Hydraulic with vacuum power assist, dual-circuit with load-dependent brake proportioning valve at rear wheels
	Front / rear	Disc brake (217 x 24)
	Parking brake	Mechanical expanding brake on drive shaft at rear of transmission
	Auxiliary brake	Exhaust brake (50 kW)
Suspension	Front / rear	Independent wheel suspension (coil spring) with shock absorber / semi-elliptic leaf spring with shock absorber and stabiliser
Frame	Type	Ladder-type frame with reinforcements and crossmembers
Fuel tank capacity		70 litres
Electrical system	Batteries	12 V (100 Ah - 760 A(EN))

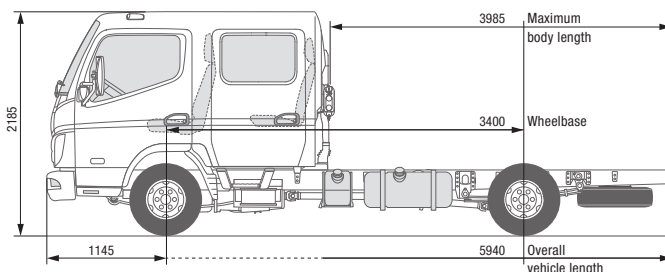
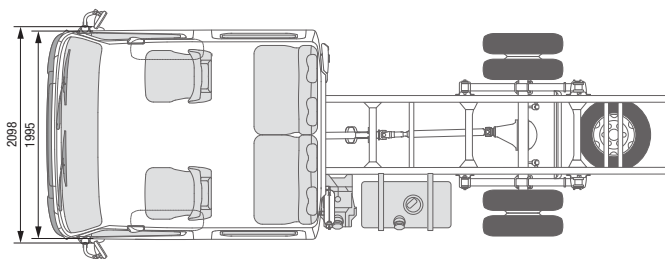

CANTER 3C15D

LEFT-HAND DRIVE

MODEL / VEHICLE TYPE 3C15D

Cab type / crew	Comfort, crew cab / 6
Model variant	46906513
FUSO model code	FEB01EL4WEUX

DIMENSIONS [MM]

Wheelbase		3400
Overall length		5940
Cab length		2625
Width overall		2098
Cab width		1995
Height overall		2185
Track width	Front / rear	1665 / 1500
Frame height (at end of frame)		755
Ground clearance		165
Cab to rear axle		1875
Cab to end of frame		3270
Maximum body length**		3985
Frame width		750
Front overhang		1145
Rear overhang		1395
Front axle to front of body		1625
Recommended distance cab to body		100

WEIGHTS [KG]

Empty weight*		2295
	Front* / rear*	1675 / 620
Minimum vehicle weight		2535
Gross vehicle weight / gross combination weight		3500 / 7000
Axle loads*	Front / rear	1950 / 2500
	Braked / unbraked	3500 / 750
Chassis load bearing capacity*		1205

CALCULATED OUTPUT

Maximum speed	km/h	136
Minimum turning circle [m]	Kerb to kerb	11.2
	Wall to wall	12.6

* The weight refers to the base vehicle (European series, including coolant, oil, 90% fuel, tyre sealant, tools and driver with 75 kg) without optional equipment. If any optional equipment is added, the weight changes accordingly. ** Calculated maximum value which should be checked depending on the body and application. Subject to change without notice. All data is approximate. The illustrations may contain accessories and items of optional equipment which are not part of the standard specification. The data sheet may contain product types and support services not available in certain countries.

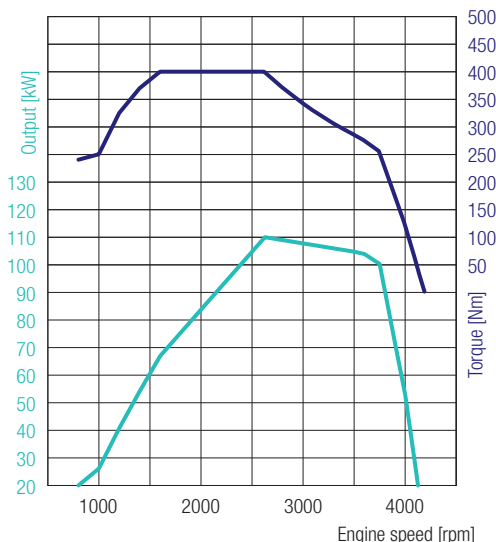

CANTER 3C15D

LEFT-HAND DRIVE

4P10 – 110 kW (150 PS)
 400 Nm@1600 rpm
 110 kW@2626 rpm

ENGINE (EURO VI)

Type	Water-cooled four-stroke diesel engine with turbocharger, intercooler and direct injection		
No. of cylinders	4/in-line		
Capacity	2998 cm ³		
Peak output	110 kW (150 hp) / 2626 rpm		
Rated torque	400 Nm / 1600 rpm		
Diesel particulate filter	Service life approx. 300,000 km		
Alternator	Alternating current 12 V, 140 A		
Exhaust gas aftertreatment	DPF + SCR		
PTO (optional)	Type	31 kW with flange	31 kW for directly connected pumps
	Torque at peak output [Nm]:	196 Nm	
	Gear ratios	1:0.655	1:0.651
	Engine speed at peak output	1500 rpm	

POWERTRAIN

Transmission	Model	Manual gearbox, 5 forward gears, 1 reverse gear
	Gear ratio	5.494 / 3.193 / 1.689 / 1.000 / 0.723 / reverse 5.494
Rear axle gear ratio	Ratio	4.111

CHASSIS

Front axle / rear axle	Model	F100T / R015T
	Load-bearing capacity front/rear	1950 kg / 2500 kg
Tyres		195/75R16C 107/105 R
		Twin tyres at rear
Wheel		16 x 5 JK - 110
Steering		Left-hand drive
		Rack-and-pinion steering with power assist, tilting telescopic steering column with steering-wheel lock
Brake	Service brake	Hydraulic with vacuum power assist, dual-circuit with load-dependent brake proportioning valve at rear wheels
	Front / rear	Disc brake (217 x 24)
	Parking brake	Mechanical expanding brake on drive shaft at rear of transmission
	Auxiliary brake	Exhaust brake (50 kW)
Suspension	Front / rear	Independent wheel suspension (coil spring) with shock absorber / semi-elliptic leaf spring with shock absorber and stabiliser
Frame	Type	Ladder-type frame with reinforcements and crossmembers
Fuel tank capacity		70 litres
Electrical system	Batteries	12 V (100 Ah - 760 A(EN))

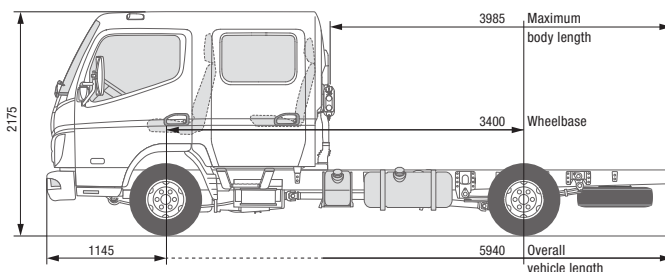
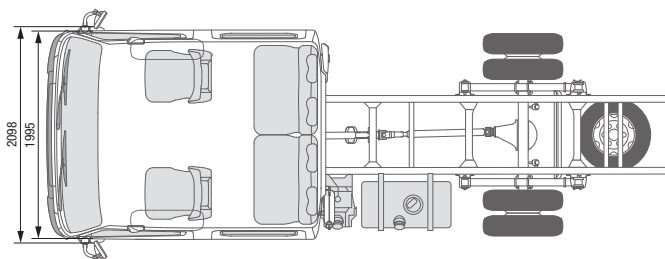

CANTER 3C15D DUONIC® 2.0 LEFT-HAND DRIVE

MODEL / VEHICLE TYPE		3C15D
Cab type / crew		Comfort, crew cab / 6
Model variant		46907513
FUSO model code		FEB01EL3WEUX
DIMENSIONS [MM]		
Wheelbase		3400
Overall length		5940
Cab length		2625
Width overall		2098
Cab width		1995
Height overall		2175
Track width		Front / rear 1665 / 1500
Frame height (at end of frame)		760
Ground clearance		165
Cab to rear axle		1875
Cab to end of frame		3270
Maximum body length**		3985
Frame width		750
Front overhang		1145
Rear overhang		1395
Front axle to front of body		1625
Recommended distance cab to body		100
WEIGHTS [KG]		
Empty weight*		2315
Front* / rear*		1690 / 625
Minimum vehicle weight		2565
Gross vehicle weight / gross combination weight		3500 / 7000
Axle loads*		Front / rear 1950 / 2500
Towed weight		Braked / unbraked 3500 / 750
Chassis load bearing capacity*		1185
CALCULATED OUTPUT		
Maximum speed		km/h 137
Minimum turning circle [m]		Kerb to kerb 11.2
		Wall to wall 12.6

* The weight refers to the base vehicle (European series, including coolant, oil, 90% fuel, tyre sealant, tools and driver with 75 kg) without optional equipment. If any optional equipment is added, the weight changes accordingly. ** Calculated maximum value which should be checked depending on the body and application. Subject to change without notice. All data is approximate. The illustrations may contain accessories and items of optional equipment which are not part of the standard specification. The data sheet may contain product types and support services not available in certain countries.

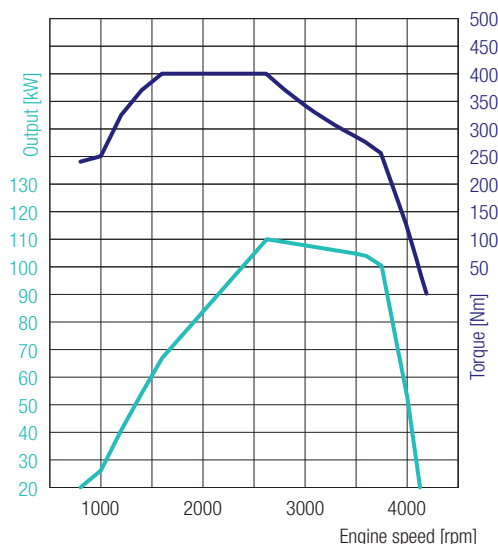

CANTER 3C15D DUONIC® 2.0

LEFT-HAND DRIVE

4P10 – 110 kW (150 PS)
 400 Nm@1600 rpm
 110 kW@2626 rpm

ENGINE (EURO VI)

Type	Water-cooled four-stroke diesel engine with turbocharger, intercooler and direct injection		
No. of cylinders	4/in-line		
Capacity	2998 cm ³		
Peak output	110 kW (150 hp) / 2626 rpm		
Rated torque	400 Nm / 1600 rpm		
Diesel particulate filter	Service life approx. 300,000 km		
Alternator	Alternating current 12 V, 140 A		
Exhaust gas aftertreatment	DPF + SCR		
PTO (optional)	Type	31 kW with flange	31 kW for directly connected pumps
	Torque at peak output [Nm]:	196 Nm	
	Gear ratios	1:0.655	1:0.651
	Engine speed at peak output	1500 rpm	

POWERTRAIN

Transmission	Model	DUONIC® 2.0: Automated transmission with dual clutch, 6 forward speeds and 1 reverse gear	
	Gear ratio	5.397 / 3.788 / 2.310 / 1.474 / 1.000 / 0.701 / reverse 5.397	
Rear axle gear ratio	Ratio	4.444	

CHASSIS

Front axle / rear axle	Model	F100T / R015T	
	Load-bearing capacity front/rear	1950 kg / 2500 kg	
Tyres		195/75R16C 107/105 R	
		Twin tyres at rear	
Wheel		16 x 5 JK - 110	
Steering		Left-hand drive	
		Rack-and-pinion steering with power assist, tilting telescopic steering column with steering-wheel lock	
Brake	Service brake	Hydraulic with vacuum power assist, dual-circuit with load-dependent brake proportioning valve at rear wheels	
	Front / rear	Disc brake (217 x 24)	
	Parking brake	Mechanical expanding brake on drive shaft at rear of transmission	
	Auxiliary brake	Exhaust brake (50 kW)	
Suspension	Front / rear	Independent wheel suspension (coil spring) with shock absorber / semi-elliptic leaf spring with shock absorber and stabiliser	
Frame	Type	Ladder-type frame with reinforcements and crossmembers	
Fuel tank capacity		70 litres	
Electrical system	Batteries	12 V (100 Ah - 760 A(EN))	

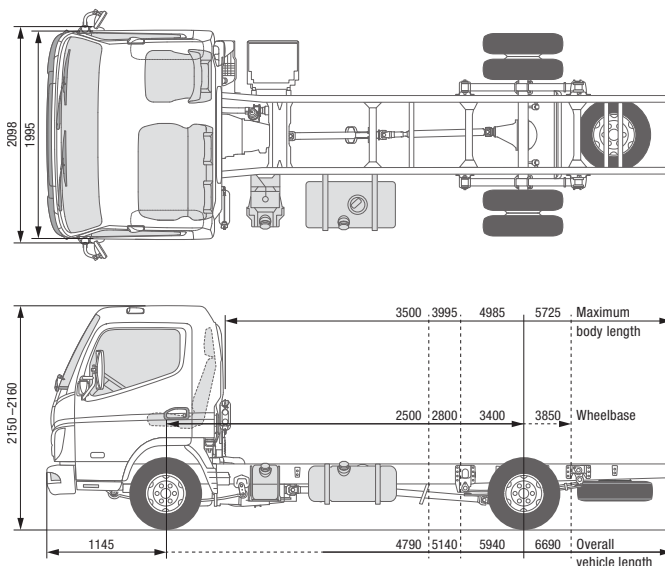

CANTER 3C15 DUONIC® 2.0 RIGHT-HAND DRIVE

MODEL / VEHICLE TYPE 3C15

Cab type / crew	Comfort, single cab / 3			
Model variant	46907221	46907321	46907521	46907721
FUSO model code	FEB01BR3SEUX	FEB01CR3SEUX	FEB01ER3SEUX	FEB01GR3SEUX

DIMENSIONS [MM]

Wheelbase	2500	2800	3400	3850
Overall length	4790	5140	5940	6690
Cab length	1625			
Width overall	2098			
Cab width	1995			
Height overall	2160	2155	2155	2150
Track width	Front / rear		1665 / 1500	
Frame height (at end of frame)	745		765	770
Ground clearance	165			
Cab to rear axle	1975	2275	2875	3325
Cab to end of frame	3120	3470	4270	5020
Maximum body length**	3500	3995	4985	5725
Frame width	750			
Front overhang	1145			
Rear overhang	1145	1195	1395	1695
Front axle to front of body	625			
Recommended distance cab to body	100			

WEIGHTS [KG]

Empty weight*		2060	2070	2095	2110
	Front* / rear*	1525 / 535	1540 / 530	1550 / 545	1565 / 545
Minimum vehicle weight		2310	2335	2350	2370
Gross vehicle weight / gross combination weight		3500 / 7000			
Axle loads*	Front / rear	1950 / 2500			
Towed weight	Braked / unbraked	3500 / 750			
Chassis load bearing capacity*		1440	1430	1405	1390

CALCULATED OUTPUT

Maximum speed	km/h	139			
Minimum turning circle [m]	Kerb to kerb	8.6	9.4	11.2	12.4
	Wall to wall	10.0	11.0	12.6	14.0

* The weight refers to the base vehicle (European series, including coolant, oil, 90% fuel, tyre sealant, tools and driver with 75 kg) without optional equipment. If any optional equipment is added, the weight changes accordingly. ** Calculated maximum value which should be checked depending on the body and application. Subject to change without notice. All data is approximate. The illustrations may contain accessories and items of optional equipment which are not part of the standard specification. The data sheet may contain product types and support services not available in certain countries.

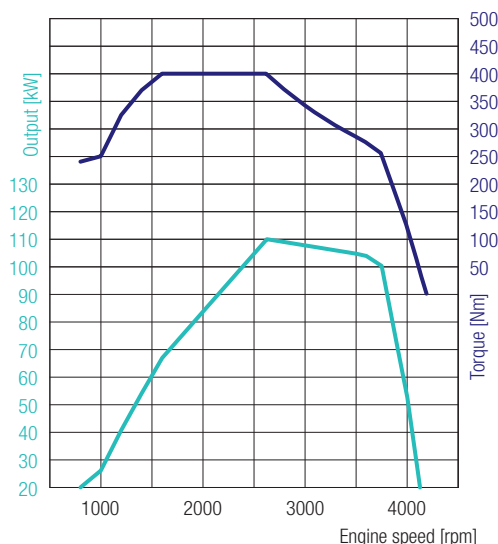

4P10 – 110 kW (150 PS)
 400 Nm@1600 rpm
 110 kW@2626 rpm

CANTER 3C15 DUONIC® 2.0 RIGHT-HAND DRIVE

ENGINE (EURO VI)

Type	Water-cooled four-stroke diesel engine with turbocharger, intercooler and direct injection		
No. of cylinders	4/in-line		
Capacity	2998 cm ³		
Peak output	110 kW (150 hp) / 2626 rpm		
Rated torque	400 Nm / 1600 rpm		
Diesel particulate filter	Service life approx. 300,000 km		
Alternator	Alternating current 12 V, 140 A		
Exhaust gas aftertreatment	DPF + SCR		
PTO (optional)	Type	31 kW with flange	31 kW for directly connected pumps
	Torque at peak output [Nm]:	196 Nm	
	Gear ratios	1:0.655	1:0.651
	Engine speed at peak output	1500 rpm	

POWERTRAIN

Transmission	Model	DUONIC® 2.0: Automated transmission with dual clutch, 6 forward speeds and 1 reverse gear
	Gear ratio	5.397 / 3.788 / 2.310 / 1.474 / 1.000 / 0.701 / reverse 5.397
Rear axle gear ratio	Ratio	4.111

CHASSIS

Front axle / rear axle	Model	F100T / R015T
	Load-bearing capacity front/rear	1950 kg / 2500 kg
Tyres		195/75R16C 107/105 R
		Twin tyres at rear
Wheel		16 x 5 JK - 110
Steering		Right-hand drive
		Rack-and-pinion steering with power assist, tilting telescopic steering column with steering-wheel lock
Brake	Service brake	Hydraulic with vacuum power assist, dual-circuit with load-dependent brake proportioning valve at rear wheels
	Front / rear	Disc brake (217 x 24)
	Parking brake	Mechanical expanding brake on drive shaft at rear of transmission
	Auxiliary brake	Exhaust brake (50 kW)
Suspension	Front / rear	Independent wheel suspension (coil spring) with shock absorber / semi-elliptic leaf spring with shock absorber and stabiliser
Frame	Type	Ladder-type frame with reinforcements and crossmembers
Fuel tank capacity		70 litres
Electrical system	Batteries	12 V (100 Ah - 760 A(EN))

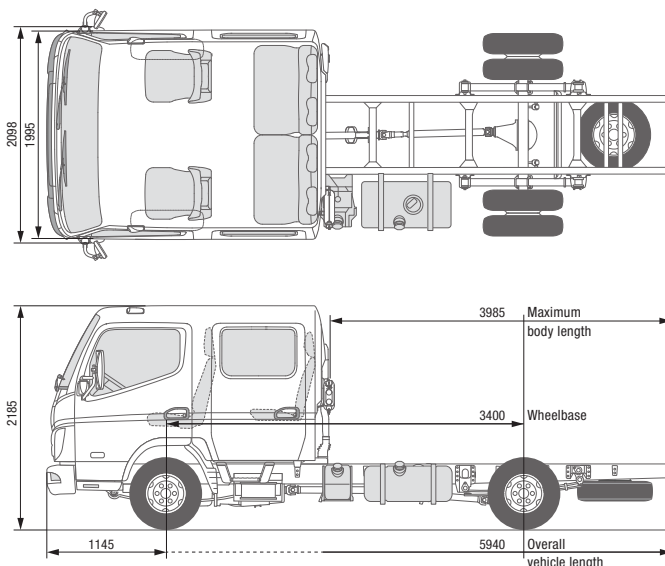

CANTER 3C15D RIGHT-HAND DRIVE

MODEL / VEHICLE TYPE		3C15D
Cab type / crew		Comfort, crew cab / 6
Model variant		46906523
FUSO model code		FEB01ER4WEUX
DIMENSIONS [MM]		
Wheelbase		3400
Overall length		5940
Cab length		2625
Width overall		2098
Cab width		1995
Height overall		2185
Track width		Front / rear 1665 / 1500
Frame height (at end of frame)		755
Ground clearance		165
Cab to rear axle		1875
Cab to end of frame		3270
Maximum body length**		3985
Frame width		750
Front overhang		1145
Rear overhang		1395
Front axle to front of body		1625
Recommended distance cab to body		100
WEIGHTS [KG]		
Empty weight*		2295
Front* / rear*		1675 / 620
Minimum vehicle weight		2535
Gross vehicle weight / gross combination weight		3500 / 7000
Axle loads*		Front / rear 1950 / 2500
Towed weight		Braked / unbraked 3500 / 750
Chassis load bearing capacity*		1205
CALCULATED OUTPUT		
Maximum speed		km/h 136
Minimum turning circle [m]		Kerb to kerb 11.2
		Wall to wall 12.6

* The weight refers to the base vehicle (European series, including coolant, oil, 90% fuel, tyre sealant, tools and driver with 75 kg) without optional equipment. If any optional equipment is added, the weight changes accordingly. ** Calculated maximum value which should be checked depending on the body and application. Subject to change without notice. All data is approximate. The illustrations may contain accessories and items of optional equipment which are not part of the standard specification. The data sheet may contain product types and support services not available in certain countries.

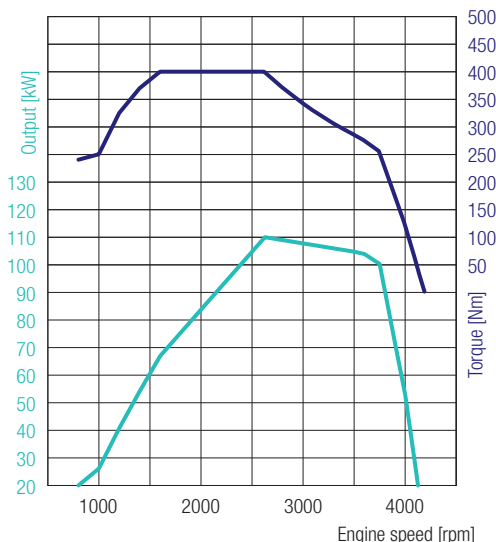

4P10 – 110 kW (150 PS)
 400 Nm@1600 rpm
 110 kW@2626 rpm

CANTER 3C15D

RIGHT-HAND DRIVE

ENGINE (EURO VI)

Type	Water-cooled four-stroke diesel engine with turbocharger, intercooler and direct injection		
No. of cylinders	4/in-line		
Capacity	2998 cm ³		
Peak output	110 kW (150 hp) / 2626 rpm		
Rated torque	400 Nm / 1600 rpm		
Diesel particulate filter	Service life approx. 300,000 km		
Alternator	Alternating current 12 V, 140 A		
Exhaust gas aftertreatment	DPF + SCR		
PTO (optional)	Type	31 kW with flange	31 kW for directly connected pumps
	Torque at peak output [Nm]:	196 Nm	
	Gear ratios	1:0.655	1:0.651
	Engine speed at peak output	1500 rpm	

POWERTRAIN

Transmission	Model	Manual gearbox, 5 forward gears, 1 reverse gear
	Gear ratio	5.494 / 3.193 / 1.689 / 1.000 / 0.723 / reverse 5.494
Rear axle gear ratio	Ratio	4.111

CHASSIS

Front axle / rear axle	Model	F100T / R015T
	Load-bearing capacity front/rear	1950 kg / 2500 kg
Tyres		195/75R16C 107/105 R
		Twin tyres at rear
Wheel		16 x 5 JK - 110
Steering		Right-hand drive
		Rack-and-pinion steering with power assist, tilting telescopic steering column with steering-wheel lock
Brake	Service brake	Hydraulic with vacuum power assist, dual-circuit with load-dependent brake proportioning valve at rear wheels
	Front / rear	Disc brake (217 x 24)
	Parking brake	Mechanical expanding brake on drive shaft at rear of transmission
	Auxiliary brake	Exhaust brake (50 kW)
Suspension	Front / rear	Independent wheel suspension (coil spring) with shock absorber / semi-elliptic leaf spring with shock absorber and stabiliser
Frame	Type	Ladder-type frame with reinforcements and crossmembers
Fuel tank capacity		70 litres
Electrical system	Batteries	12 V (100 Ah - 760 A(EN))

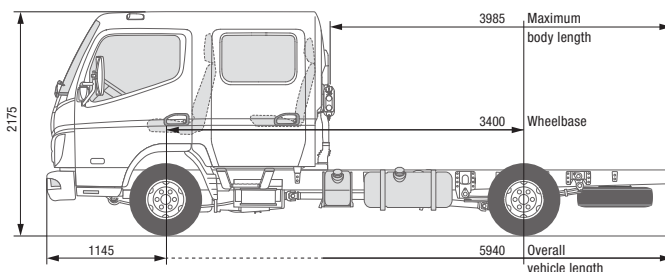
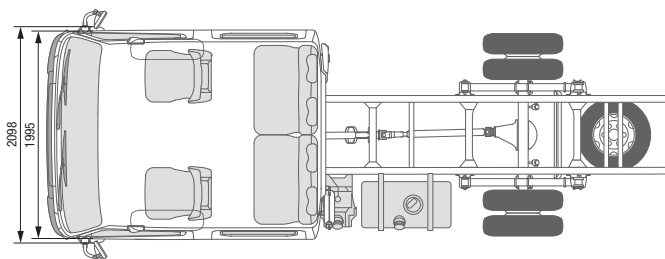

CANTER 3C15D DUONIC® 2.0 RIGHT-HAND DRIVE

MODEL / VEHICLE TYPE		3C15D
Cab type / crew		Comfort, crew cab / 6
Model variant		46907523
FUSO model code		FEB01ER3WEUX
DIMENSIONS [MM]		
Wheelbase		3400
Overall length		5940
Cab length		2625
Width overall		2098
Cab width		1995
Height overall		2175
Track width		Front / rear
		1665 / 1500
Frame height (at end of frame)		760
Ground clearance		165
Cab to rear axle		1875
Cab to end of frame		3270
Maximum body length**		3985
Frame width		750
Front overhang		1145
Rear overhang		1395
Front axle to front of body		1625
Recommended distance cab to body		100
WEIGHTS [KG]		
Empty weight*		2315
		Front* / rear*
		1690 / 625
Minimum vehicle weight		2565
Gross vehicle weight / gross combination weight		3500 / 7000
Axle loads*		Front / rear
		1950 / 2500
Towed weight		Braked / unbraked
		3500 / 750
Chassis load bearing capacity*		1185
CALCULATED OUTPUT		
Maximum speed		km/h
		139
Minimum turning circle [m]		Kerb to kerb
		11.2
		Wall to wall
		12.6

* The weight refers to the base vehicle (European series, including coolant, oil, 90% fuel, tyre sealant, tools and driver with 75 kg) without optional equipment. If any optional equipment is added, the weight changes accordingly. ** Calculated maximum value which should be checked depending on the body and application.
Subject to change without notice. All data is approximate. The illustrations may contain accessories and items of optional equipment which are not part of the standard specification. The data sheet may contain product types and support services not available in certain countries.

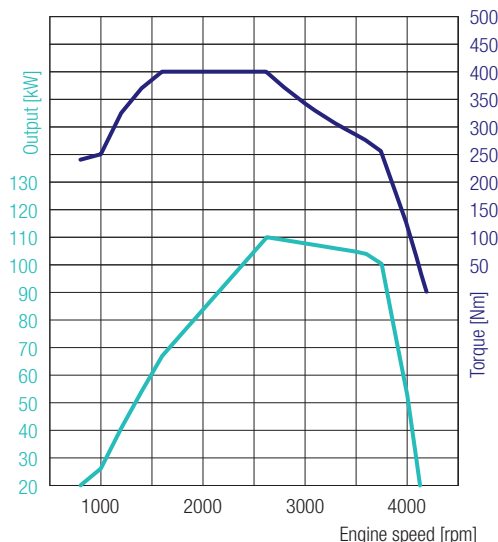

4P10 – 110 kW (150 PS)
 400 Nm@1600 rpm
 110 kW@2626 rpm

CANTER 3C15D DUONIC® 2.0 RIGHT-HAND DRIVE

ENGINE (EURO VI)

Type	Water-cooled four-stroke diesel engine with turbocharger, intercooler and direct injection		
No. of cylinders	4/in-line		
Capacity	2998 cm ³		
Peak output	110 kW (150 hp) / 2626 rpm		
Rated torque	400 Nm / 1600 rpm		
Diesel particulate filter	Service life approx. 300,000 km		
Alternator	Alternating current 12 V, 140 A		
Exhaust gas aftertreatment	DPF + SCR		
PTO (optional)	Type	31 kW with flange	31 kW for directly connected pumps
	Torque at peak output [Nm]:	196 Nm	
	Gear ratios	1:0.655	1:0.651
	Engine speed at peak output	1500 rpm	

POWERTRAIN

Transmission	Model	DUONIC® 2.0: Automated transmission with dual clutch, 6 forward speeds and 1 reverse gear
	Gear ratio	5.397 / 3.788 / 2.310 / 1.474 / 1.000 / 0.701 / reverse 5.397
Rear axle gear ratio	Ratio	4.444

CHASSIS

Front axle / rear axle	Model	F100T / R015T
	Load-bearing capacity front/rear	1950 kg / 2500 kg
Tyres		195/75R16C 107/105 R
		Twin tyres at rear
Wheel		16 x 5 JK - 110
Steering		Right-hand drive
		Rack-and-pinion steering with power assist, tilting telescopic steering column with steering-wheel lock
Brake	Service brake	Hydraulic with vacuum power assist, dual-circuit with load-dependent brake proportioning valve at rear wheels
	Front / rear	Disc brake (217 x 24)
	Parking brake	Mechanical expanding brake on drive shaft at rear of transmission
	Auxiliary brake	Exhaust brake (50 kW)
Suspension	Front / rear	Independent wheel suspension (coil spring) with shock absorber / semi-elliptic leaf spring with shock absorber and stabiliser
Frame	Type	Ladder-type frame with reinforcements and crossmembers
Fuel tank capacity		70 litres
Electrical system	Batteries	12 V (100 Ah - 760 A(EN))